

Dalton[®]

INSTRUCTION MANUAL

KS8Pro

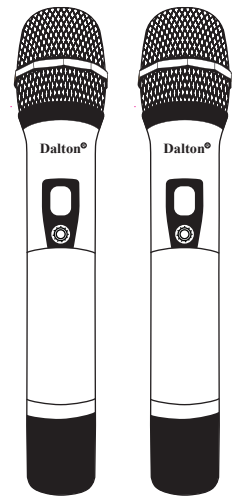
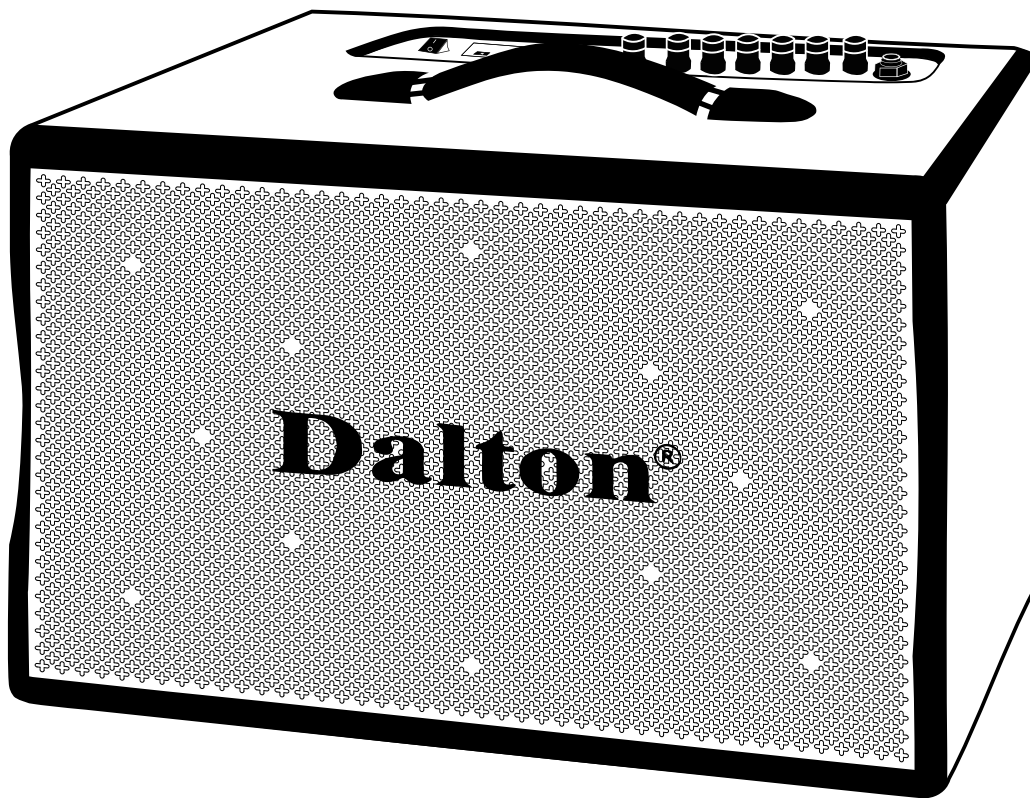

UHF Microphone

TABLE OF CONTENTS

I. IMPORTANT SAFETY INSTRUCTIONS	1
II. SPECIFICATIONS	2
III. DESCRIPTION OF FUNCTIONS	3
1. POWER	3
2. MUSIC PLAYER FUNCTIONS: Bluetooth/USB	3
3. MUSIC CONTROL	4
4. MIC CONTROL	4
5. HOW TO CONNECT MICROPHONE WITH THE SPEAKER	4
6. HOW TO SET WIRELESS MICROPHONE FREQUENCY	4
7. HOW TO CHANGE MICROPHONE FREQUENCY CHANNEL	5
8. STANDARD CALIBRATION LEVEL FOR DALTON SPEAKER	5
IV. FCC STATEMENT	6

I. IMPORTANT SAFETY INSTRUCTIONS



Warning: to reduce the risk of electric shock, do not overexpose this appliance to rain or moisture.

Warning: the mains plug or AC inlet is used as disconnect device. The disconnect device shall remain readily operable.

Warning: connect only to mains socket with protective earthing connection.

Warning: to reduce the risk of electric shock, do not remove cover (or back) as there are no user-servicable parts inside. Refer servicing to qualified personnel.



- The lightning flash with arrowhead symbol, within an equilateral triangle is intended to alert the user to the presence of uninsulated “dangerous voltage” within the product’s enclosure that may be sufficient magnitude to constitute a risk of electric shock to persons.



- The exclamation point within an equilateral triangle is intended to alert the user to the presence of important operating and maintenance (servicing) instructions in the literature accompanying the appliance.

1. Read these instructions.
2. Keep these instructions.
3. Heed all warnings.
4. Follow all instructions.
5. Do not use this apparatus near water.
6. Clean only with a dry cloth.
7. Do not install near any heat sources such as radiators, heat register, stoves, or other apparatus that produce heat.
8. Only use attachments/ accessories specified by the manufacturer.
9. Do not expose this apparatus to dripping or splashing and ensure that no objects filled with liquids, such as vases, are placed on this apparatus.
10. Do not block any ventilation openings. Install in accordance with the manufacturers instructions.
11. Do not defeat the safety purpose of the polarized or grounding type plug. A polarized plug has two blades with one wider than the other. A grounding type plug has two blades and a third grounding prong. The wide blade or the third prong is provided for your safety. If the provided plug does not fit into your outlet, consult an electrician for replacement of the obsolete outlet.
12. Protect the power cord from being walked on or pinched particularly at plugs, convenience receptacles, and the point where they exit from the apparatus.
13. Unplug the apparatus during lightning storms or when unused for long periods of time.
14. Refer all servicing to qualified service personnel. Servicing is required when the apparatus has been damaged in any way, such as power supply cord or plug is damaged, liquid has been spilled or objects have fallen into the apparatus, the apparatus has been exposed to rain or moisture, does not operate normally, or has been dropped.
15. To completely disconnect AC power from this apparatus, the power supply cord must be unplugged.

II. SPECIFICATIONS

- Power output: 250W.
- Frequency response: 20Hz-20Khz.
- Includes 2 UHF wireless microphones.
- Microphone: Echo/Delay/Bass/Treble controls.
- USB flash drive.
- Bluetooth function.
- Built-in high capacity rechargeable lithium battery (12Vdc).
- Power voltage: AC 120V/60Hz.

FRONTSIDE MACHINE

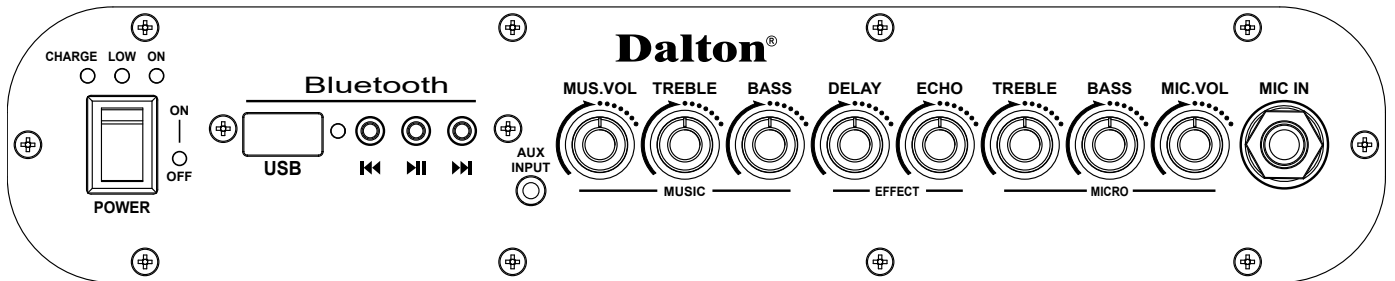

REARSIDE MACHINE

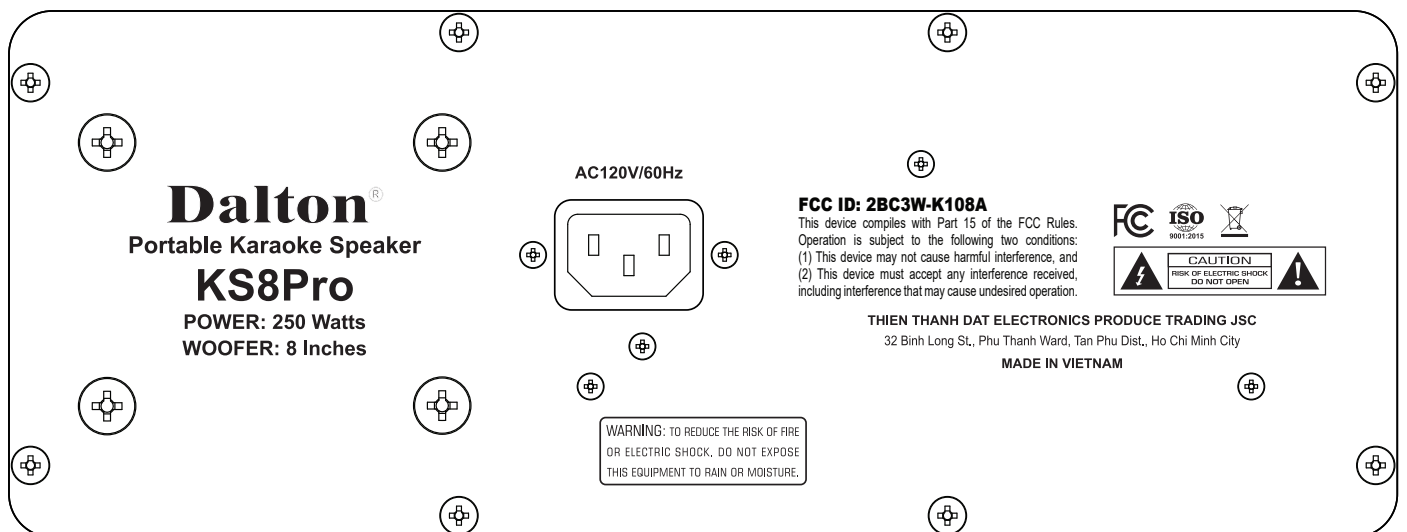

III. DESCRIPTION OF FUNCTIONS

1. POWER

• POWER: On/Off

- ON : Machine working mode.
- OFF: Machine off mode.

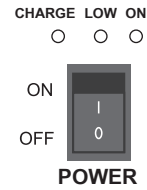

• LED LIGHTS:

- ON : Light meaning machine is on the working status.
- LOW : Light meaning rechargeable battery built-in needs to be charged.
- CHARGE : Light meaning rechargeable battery built-in is on the charging status.

• AC-120V/60Hz: Connect power plug to recharge the battery or use the machine.

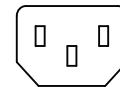

• How to keep the battery last longer:

- Charge the battery machine every time the LED light show “LOW”.
- LED light “CHARGE” changing from red to blue once the battery is full stop charging.
- Turn off the power switch to charge the battery.
- If machine do not operate more than 30 days, it is recommended to charge the battery.

2. MUSIC PLAYER FUNCTIONS: Bluetooth/USB

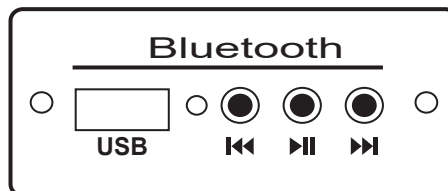



How to connect Bluetooth from speaker KS8Pro to other devices:

- Step 1: Turn on speaker power.
- Step 2: Turn on Bluetooth from your device (TV, IPHONE, IPAD, Android...).
- Step 3: Select ID “Dalton BT03” on the device, your Bluetooth speaker should be paired (connect) to your player device.

To disconnect the Bluetooth of the speaker just hold Pause/Play  key about 3 seconds.

Functions key on the screen:

-  : **Pause/Play**.
 - + Pause/Play song.
 - + Hold about 3 seconds to disconnect/ reconnect the speaker’s Bluetooth with your device.
-  : **Prev**
 - + PREV go back to the previous song.
-  : **Next**
 - + NEXT go the next song.

3. MUSIC CONTROL

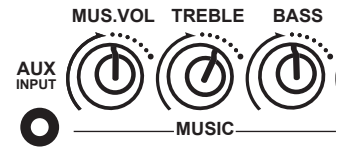

- **MUS.VOL** : Control increase/decrease music volume level.
- **TREBLE** : Control increase/decrease the amount of treble (hi) frequency response for music.
- **BASS** : Control increase/decrease the amount of bass (low) frequency response for music.
- **AUX INPUT** : Connect 3.5mm mono audio cable to outside player such as TV, smartphone ...

4. MIC CONTROL

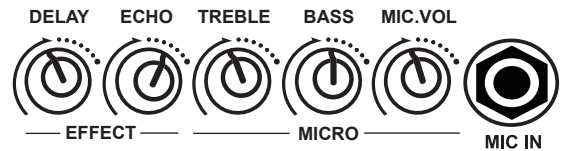

- **DELAY** : Control increase/decrease the amount of delay applied to the microphone.
- **ECHO** : Control increase/decrease the amount of echo applied to the microphone.
- **TREBLE** : Control increase/decrease the amount of treble (hi) frequency applied to the microphone.
- **BASS** : Control increase/decrease the amount of bass (low) frequency applied to the microphone.
- **MIC.VOL** : Control increase/decrease volume level for the 2 wireless microphones include in the machine and external microphone.
- **MIC IN** : Connector for wire or wireless external microphone.

5. HOW TO CONNECT MICROPHONE WITH THE SPEAKER

POWER SWITCH ON/OFF

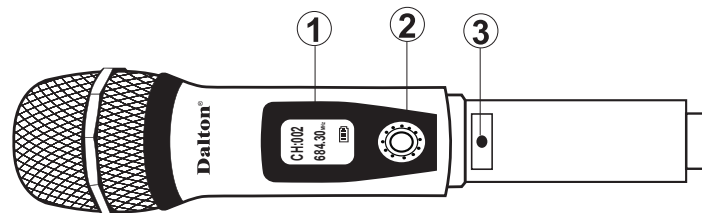
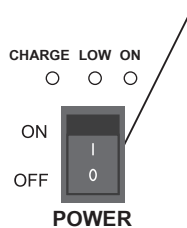

- ① LCD
- ② POWER SWITCH ON/OFF
- ③ SET

- Step 1: Turn off speaker and microphone power.
- Step 2: Press and hold “SET” button and microphone power switch at the same time, the LCD screen displays “Ld---” start flashing.
- Step 3: Turn on speaker power.
- Step 4: After 5 seconds, press the microphone power switch to connect the frequency with the speaker.

6. HOW TO SET WIRELESS MICROPHONE FREQUENCY

- Step 1: Turn on Microphone.
- Step 2: Press “SET” button continuously on the microphone to select the frequency desired. Turn off microphone power.
- Step 3: Follow the steps as in section 5 of part III.

7. HOW TO CHANGE MICROPHONE FREQUENCY CHANNEL

Microphone has two frequency channels

- Channel 1: 657.00 MHz - 662.85 MHz
- Channel 2: 684.00 MHz - 693.00 MHz

KS8Pro speaker receives frequency channel 1. If the microphone displays the wrong frequency channel, please follow these steps:

- Step 1: Turn on microphone.
- Step 2: Press and hold the power button, then press and hold the "set" button at the same time until the LCD displays "CH-1" (Micro A) or "CH-2" (Micro B).
- Step 3: Turn on microphone, check the frequency displayed on the LCD.

8. STANDARD CALIBRATION LEVEL FOR DALTON SPEAKER

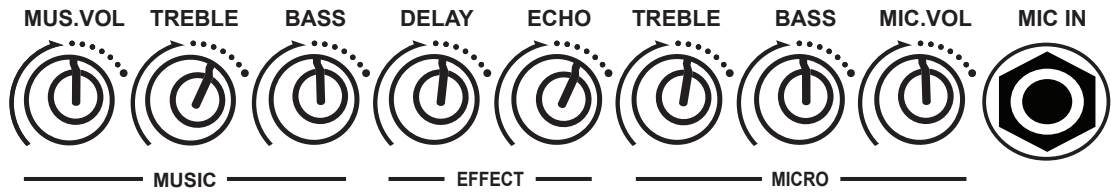

- The picture just for reference.

IV. FCC STATEMENT

This device complies with Part 15 of the FCC Rules. Operation is subject to the following two conditions:

- (1) This device may not cause harmful interference, and
- (2) This device must accept any interference received, including interference that may cause undesired operation.

Warning: Changes or modifications not expressly approved by the party responsible for compliance could void the user's authority to operate the equipment.

NOTE: This equipment has been tested and found to comply with the limits for a Class B digital device, pursuant to Part 15 of the FCC Rules. These limits are designed to provide reasonable protection against harmful interference in a residential installation. This equipment generates uses and can radiate radio frequency energy and, if not installed and used in accordance with the instructions, may cause harmful interference to radio communications. However, there is no guarantee that interference will not occur in a particular installation. If this equipment does cause harmful interference to radio or television reception, which can be determined by turning the equipment off and on, the user is encouraged to try to correct the interference by one or more of the following measures:

Reorient or relocate the receiving antenna.

Increase the separation between the equipment and receiver.

Connect the equipment into an outlet on a circuit different from that to which the receiver is connected.

Consult the dealer or an experienced radio/TV technician for help.

FCC Radiation Exposure Statement:

This equipment complies with FCC radiation exposure limits set forth for an uncontrolled environment. This equipment should be installed and operated with minimum distance 20cm between the radiator & your body.

Customer Service Center



Contact us: +1 713-289-0509



Dalton Audio Inc



www.dalton-audio.com



fb.com/DaltonAudio